

Perfil T em PE-100 verde p/ corrente simples

Tipos	Correntes	Ref.º ISO	B	A	b	a
T0	3/8" x 7/32"	06 B1	15	10	5,4	1,5
T1	1/2" x 5/16"	08 B1	20	10-15-20	7,4	2,2
T2	5/8" x 3/8"	10 B1	20	10-15-20	9,2	2,6
T3	3/4" x 7/16"	12 B1	25	10-15-20	11,3	2,4
T4	1" x 17mm	16 B1	40	15-20	16,5	3,5
T5	1 1/4" x 3 3/4"	20 B1	45	15-20	19,0	4,3
*T6	1 1/2" x 1"	24 B1	60	15-20	24,6	5,6
*T7	1 3/4" x 31mm	28 B1	75	20	30,0	6,9
*T8	2" x 31mm	32 B1	80	20	30,0	7,8

* Por encomenda

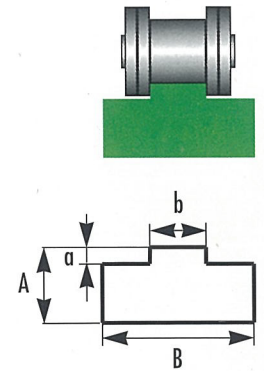

Fig. 50

Perfil T em PE-100 verde p/ corrente duplo

Tipos	Correntes	Ref.º ISO	B	A	b	a	c
T0.2	3/8" x 7/32"	06 B2	25	10	5,4	1,5	15,74
T1.2	1/2" x 5/16"	08 B2	35	10-15-20	7,4	2,2	21,42
T2.2	5/8" x 3/8"	10 B2	40	10-15-20	9,2	2,6	25,79
T3.2	3/4" x 7/16"	12 B2	45	15-20	11,3	2,4	30,76
T4.2	1" x 17mm	16 B2	65	15-20	16,5	3,5	48,38
*T5.2	1 1/4" x 3 3/4"	20 B2	70	15-20	19,0	4,3	54,45
*T6.2	1 1/2" x 1"	24 B2	88	20	24,6	5,6	72,96
*T7.2	1 3/4" x 31mm	28 B2	105	25	30,0	6,9	89,56
*T8.2	2" x 31mm	32 B2	105	30	30,0	7,8	88,55

* Por encomenda

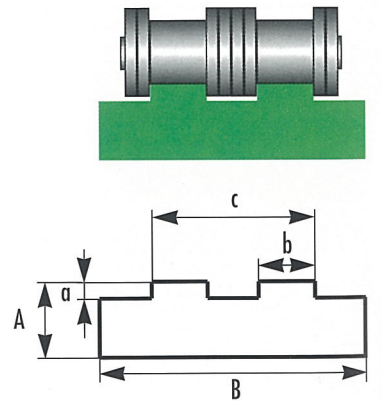

Fig. 51

Perfil T em PE-100 verde p/ corrente triplo

Tipos	Correntes	Ref.º ISO	B	A	b	a	c
T0.3	3/8" x 7/32"	06 B3	35	10	5,4	1,5	25,88
T1.3	1/2" x 5/16"	08 B3	45	10-15-20	7,4	2,2	35,24
T2.3	5/8" x 3/8"	10 B3	55	10-15-20	9,2	2,6	42,38
T3.3	3/4" x 7/16"	12 B3	60	10-15-20	11,3	2,4	50,22
T4.3	1" x 17mm	16 B3	95	15-20	16,5	3,5	80,26
T5.3	1" 1/4 mm	20 B3	106	15	19	4,3	92
T6.3	1" 1/2 mm	24 B3	136	20	24,6	5,6	121,5

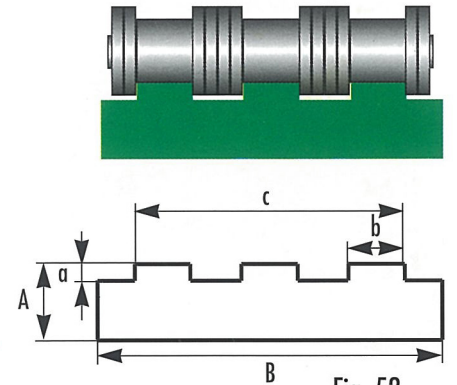

Fig. 52

Perfil E em PE-100 verde p/ corrente simples

Tipos	Correntes	Ref.º ISO	B	A	a	a1	b	b1
E 0	3/8" x 7/32"	06 B1	25	10	1,5	4,35	5,4	15
E 1	1/2" x 5/16"	08 B1	30	15	2,2	7,17	7,4	20
E 2	5/8" x 3/8"	10 B1	33	20	2,6	9,45	9,2	23
E 3	3/4" x 7/16"	12 B1	38	20	2,4	11,11	11,3	28
E 4	1" x 17mm	16 B1	51	25	3,5	16,48	16,5	41
*E 5	1 1/4" x 3 3/4"	20 B1	57	30	4,3	19,77	19,0	47
*E 6	1 1/2" x 1"	24 B1	70	40	4,5	29,40	24,6	60

* Por encomenda

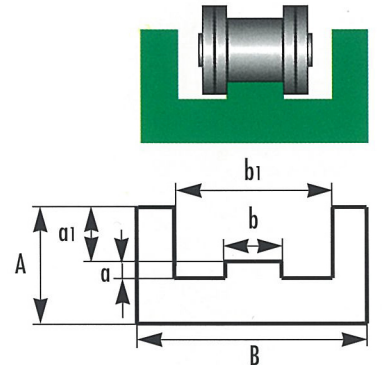

Fig. 55

Perfil E em PE-100 verde p/ corrente dupla

Tipos	Correntes	Ref.ª ISO	B	A	a	a1	b	b1
E 0.2	3/8" x 7/32"	06 B2	36	15	1,5	4,35	5,4	26
E 1.2	1/2" x 5/16"	08 B2	45	20	2,2	7,17	7,4	35
E 2.2	5/8" x 3/8"	10 B2	50	25	2,6	9,45	9,2	40
E 3.2	3/4" x 7/16"	12 B2	56	25	2,4	11,11	11,3	46
E 4.2	1" x 17mm	16 B2	85	30	3,5	16,48	16,5	75

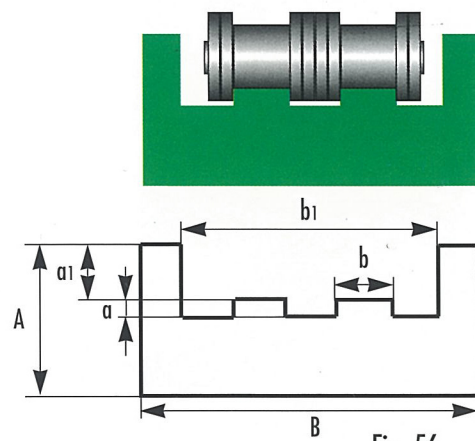

Fig. 56

Perfil BL em PE-100 verde p/ corrente simples

Tipos	Correntes	Ref.ª ISO	B	A	a1	a2	a3	d1	D	d2
*BL 0	3/8" x 7/32"	06 B1	20	25	5,6	8,7	10,0	6,6	9,3	4,0
*BL 1	1/2" x 5/16"	08 B1	24	30	7,6	11,5	13,5	8,7	13,5	5,0
*BL 2	5/8" x 3/8"	10 B1	30	35	9,5	13,5	14,8	10,4	15,4	6,0
*BL 3	3/4" x 7/16"	12 B1	40	35	11,5	16,5	17,5	12,3	17,5	7,0
*BL 4	1" x 17mm	16 B1	40	45	16,9	25,7	26,8	16,1	24,4	9,0
*BL 5	1 1/4" x 3/4"	20 B1	50	50	19,4	29,3	31,2	19,3	27,5	11,0
*BL 6	1 1/2" x 1"	24 B1	60	60	25,2	38,2	40,1	25,7	36,5	16,0
*BL 7	1 3/4" x 31mm	28 B1	60	70	30,8	46,9	48,9	28,3	41,5	17,0
*BL 8	2" x 31mm	32 B1	70	75	30,8	47,3	53,0	29,6	44,5	19,0

* Por encomenda

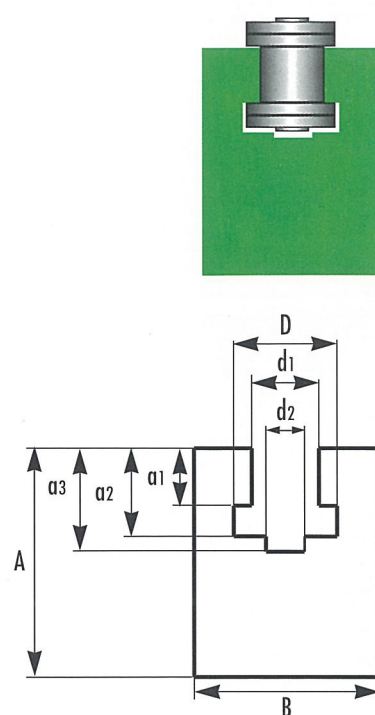

Fig. 57

Perfil U em PE-100 verde p/ corrente simples

Tipos	Correntes	Ref.ª ISO	B	A	a2	a3	d1	d2
*U 0	3/8" x 7/32"	06 B1	20	15	2,8	4,2	9,2	4
*U 1	1/2" x 5/16"	08 B1	25	15	3,5	4,8	12,7	5
*U 2	5/8" x 3/8"	10 B1	25	15	3,6	5,1	15,2	6
*U 3	3/4" x 7/16"	12 B1	25	20	3,9	5,7	16,7	7
*U 4	1" x 17mm	16 B1	35	25	8,4	10,0	24,4	9

* Por encomenda

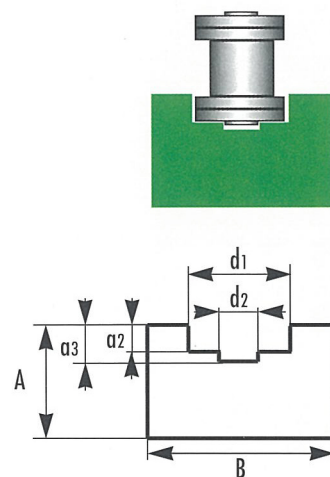

Fig. 58

Perfil CP em PE-100 verde

Tipos	B	A	α	Ac
*C1 A 5	20	5	1	6,2
*C1 A 10	20	10	6	11,2
*C1 A 15	20	15	11	16,2
C3 A 10	20	10	4	14,0
C3 A 15	20	15	7	17,0
*C3 A 20	20	20	12	22,0
*C5 A 10	28	10	3	15,0
*C5 A 15	28	15	6	18,0
*C5 A 20	28	20	12	24,0
*C9 A 10	38	10	3	21,0
*C9 A 15	38	15	6	24,0
*C9 A 20	38	20	12	30,0

Outras medidas na cota B

* Por encomenda

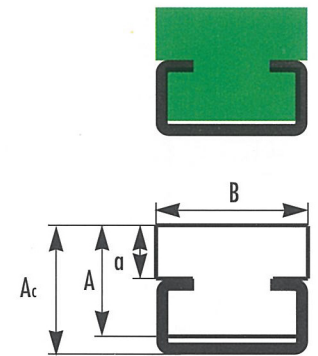

Fig. 59

Perfil CT em PE-100 verde p/ corrente simples

Tipos	Correntes	Ref.º ISO	B	A	α	b	Ac
*T0 C3 A 15	3/8" x 7/32"	06 B 1	20	15	1,5	5,4	17
*T1 C3 A 15	1/2" x 5/16"	08 B 1	20	15	2,2	7,4	17
*T2 C3 A 15	5/8" x 3/8"	10 B 1	20	15	2,6	9,2	17
*T3 C3 A 15	3/4" x 7/16"	12 B 1	20	15	2,4	11,3	17
*T4 C5 A 15	1" x 17mm	16 B 1	28	15	3,5	16,5	18
*T5 C9 A 20	1 1/4" x 3/4"	20 B 1	38	20	4,3	19,0	27

* Por encomenda

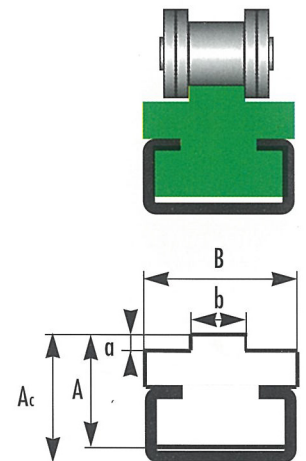

Fig. 60

Perfil CT em PE-100 verde p/ corrente dupla

Tipos	Correntes	Ref.º ISO	B	A	α	b	Ac
*T0.2 C3 A 15	3/8" x 7/32"	06 B 2	15,7	15	1,5	5,4	17
*T1.2 C3 A 15	1/2" x 5/16"	08 B 2	21,4	15	2,2	7,4	17
*T2.2 C5 A 15	5/8" x 3/8"	10 B 2	25,9	15	2,6	9,2	19
*T3.2 C5 A 15	3/4" x 7/16"	12 B 2	30,7	15	2,4	11,3	19
*T4.2 C9 A 20	1" x 17mm	16 B 2	48,3	20	3,5	16,5	27

* Por encomenda

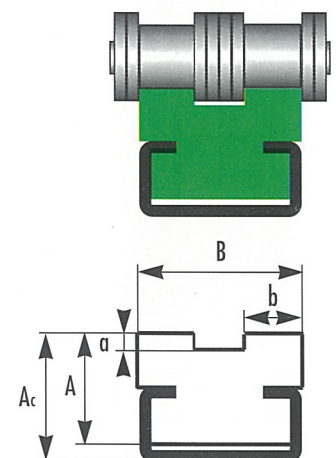

Fig. 61

Perfil CE em PE-100 verde p/ corrente simples

Tipos	Correntes	Ref.ª ISO	B	A	a	a1	b	b1	Ac
*E0 C3	3/8" x 7/32"	06 B1	25	18,0	1,5	4,35	5,4	15	20,0
*E1 C5	1/2" x 5/16"	08 B1	30	24,5	2,2	7,17	7,4	20	27,0
*E2 C5	5/8" x 3/8"	10 B1	33	29,5	2,6	9,45	9,2	23	32,0
*E3 C9	3/4" x 7/16"	12 B1	38	35,0	2,4	11,11	11,3	28	38,5
*E4 C9	1" x 17mm	16 B1	51	40,0	3,5	16,48	16,5	41	43,5

* Por encomenda

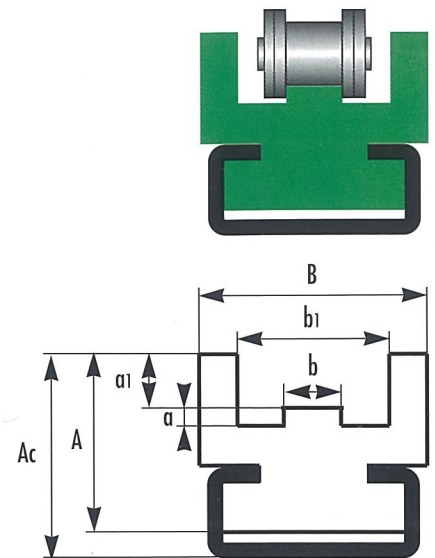

Fig. 61a

Perfil C 10 P em PE-100 verde p/ corrente simples

Tipos	Correntes	Ref.ª ISO	Ac	B	b	a
*C 10.0	3/8" x 7/32"	06 B 1	24	30	6,6	5,6
*C 10.1	1/2" x 5/16"	08 B1	24	30	8,7	7,6
*C 10.2	5/8" x 3/8"	10 B 1	24	30	10,4	9,5
*C 10.3	3/4" x 7/16"	12 B 1	24	30	12,3	11,5
*C 11.4	1" x 17mm	16 B 1	40	45	16,1	16,9

* Por encomenda

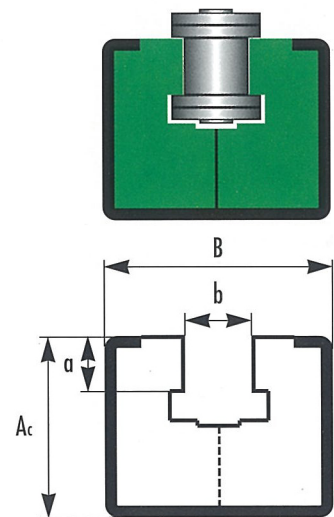
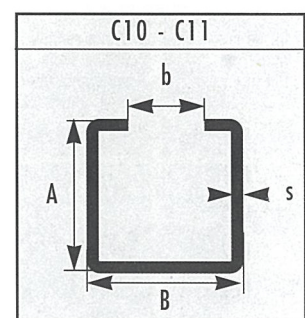
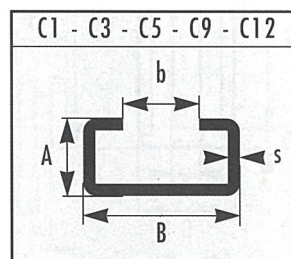

Fig. 62

Perfis metálicos		B	A	b	s
Inox AISI 304	Zincado				
C 1 i	-	24	5,2	17,5	1,0
C 3 i	C 3 z	20	10,0	10,0	1,5
C 5 i	C 5 z	28	12,0	14,0	2,0
C 9 i	C 9 z	38	18,0	22,0	2,5
C 10 i	C 10 z	30	24,0	20,0	1,5
C 11 i	C 11 z	45	40,0	31,0	2,0
-	C 12 z	60	20,0	36,0	2,5



Perfil COMBI em PE-100 verde p/ corrente simples

Tipos	Correntes	Ref.º ISO	A	B	A ₁	A ₂	A _c	b
* COMBI 0 C3	3/8" x 7/32"	06 B 1	26,4	20	31,6	19,5	28,4	17,3
COMBI 1 C3	1/2" x 5/16"	08 B 1	28,0	20	34,8	18,9	30,5	16,5
COMBI 2 C3	5/8" x 3/8"	10 B 1	34,4	20	41,1	21,2	36,0	15,5
* COMBI 3 C5	3/4" x 7/16"	12 B 1	38,5	28	47,5	24,8	41,5	22,25
* COMBI 4 C9	1" x 17mm	16 B 1	52,4	38	69,4	39,1	61,4	29,75

* Por encomenda

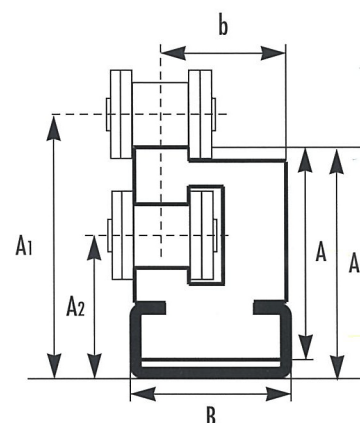
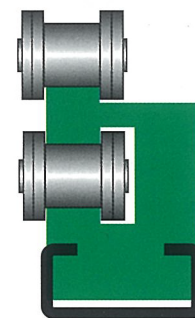

Fig. 63

Perfil CBL em PE-100 verde p/ corrente simples

Tipos	Correntes	Ref.º ISO	B	A	a ₁	a ₂	a ₃	d ₁	D	d ₂	A _c
* BL0 C3	3/8" x 7/32"	06 B1	20	25	5,6	8,7	10,0	6,6	9,3	4	27
* BL1 C5	1/2" x 5/16"	08 B1	24	30	7,6	11,5	13,5	8,7	13,5	5	33
* BL2 C5	5/8" x 3/8"	10 B1	30	35	9,5	13,5	14,8	10,4	15,4	6	38
* BL3 C9	3/4" x 7/16"	12 B1	40	35	11,5	16,5	17,5	12,3	17,5	7	39
* BL4 C9	1" x 17mm	16 B1	40	45	16,9	25,7	26,8	16,1	24,4	9	49

* Por encomenda

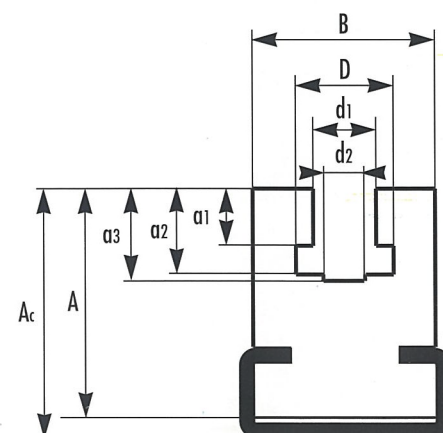
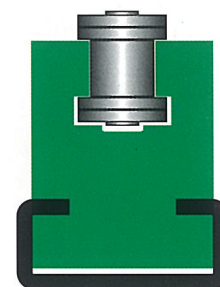
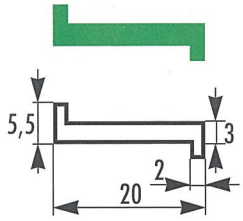

Fig. 63a

Perfis em PE 1000 verde



Código

B7.241000 verde

Embalagem: Rolos de 80 metros.

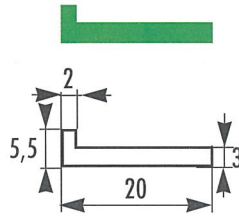

Código

B7.243000 verde

Embalagem: Rolos de 80 metros.

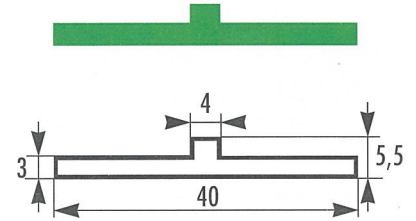

Código

B7.242000 verde

Embalagem: Rolos de 50 metros.

Perfis em PE 1000 preto / verde

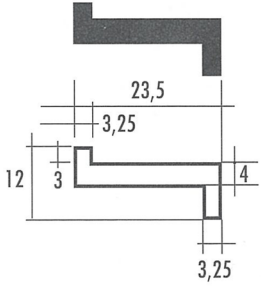

Fig. 4

Código

B7.262001 preto

Embalagem: Rolos de 50 metros.

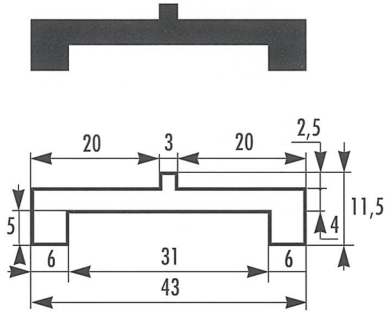

Fig. 5

Código

B7.263001 verde

Embalagem: Rolos de 50 metros.

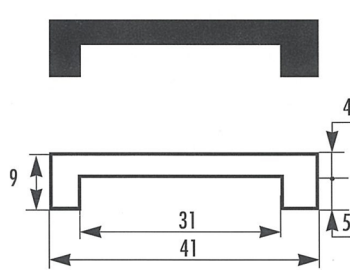

Fig. 5 a

Código

B7.362001 verde

B7.362002 preto

Embalagem: Barra de 6 metros.

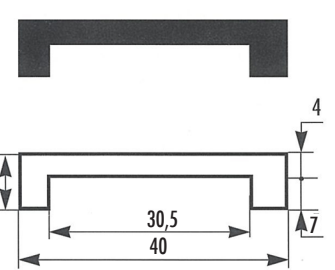

Fig. 5 b

Código

B7.362003 preto

Embalagem: Barra de 6 metros.

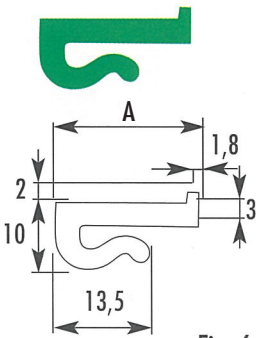

Fig. 6

Código

B7.251000 verde A=21

B7.251007 preto A=21

B7.251025 verde A=25

Embalagem: Rolos de 60 metros.

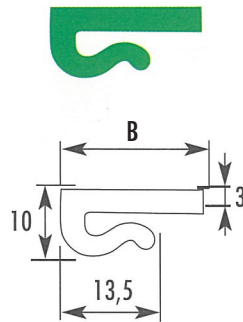

Fig. 7

Código

B7.261000 verde B=21

B7.261007 preto B=21

B7.261025 verde B=25

Embalagem: Rolos de 60 metros.

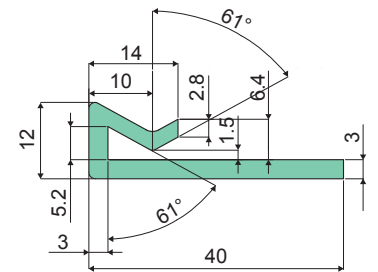

Código

B7.261040 verde

Embalagem: Rolos de 50 metros.

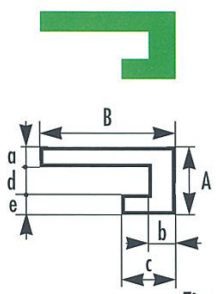

Fig. 8

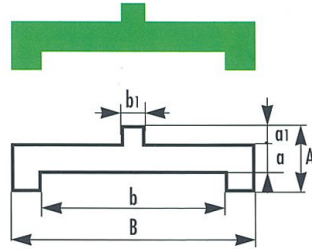

Fig. 9

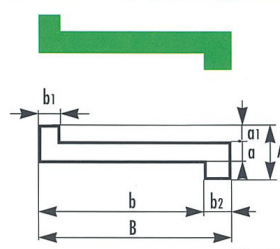

Fig. 10

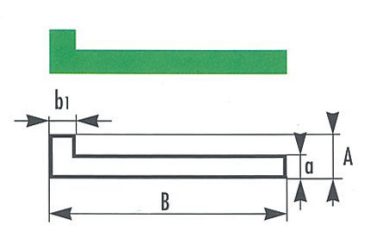

Fig. 10 a

A	B	a	a1	b	b1	b2	e	d	c
mm	mm	mm	mm	mm	mm	mm	mm	mm	mm

Para correntes TAB (880T / 881T)

Para corrente TK 3 1/4"

90° - R1 = 500 mm.

Sec. A x 25 + 25 - Parte recta 50 mm.

Código	Pistas	P.T. mm	A mm
T 3 1/4" - 500-1	1	-	100
T 3 1/4" - 500-2	2	85	185
T 3 1/4" - 500-3	3	85	270
T 3 1/4" - 500-4	4	85	355
T 3 1/4" - 500-5	5	85	440
T 3 1/4" - 500-6	6	85	525

* P.T. mm - também pode ter 88

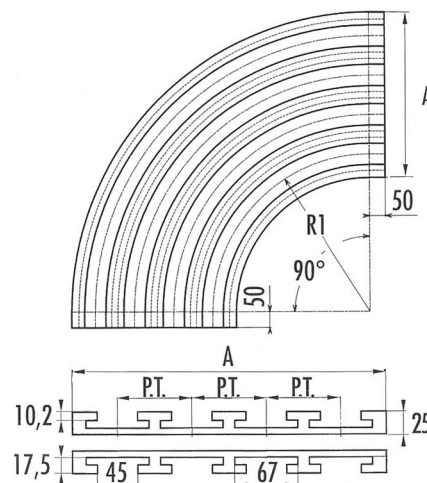

Para corrente TK 4 1/2"

90° - R1 = 500 mm.

Sec. A x 25 + 25 - Parte recta 50 mm.

Código	Pistas	P.T. mm	A mm
T 4 1/2" - 610-1	1	-	130
T 4 1/2" - 610-2	2	120	250

Para corrente TK 7 1/2"

90° - R1 = 500 mm.

Sec. A x 25 + 25 - Parte recta 50 mm.

Código	Pistas	P.T. mm	A mm
T 7 1/2" - 610-1	1	-	200
T 7 1/2" - 610-2	2	196	396

Para correntes TAB (882T)

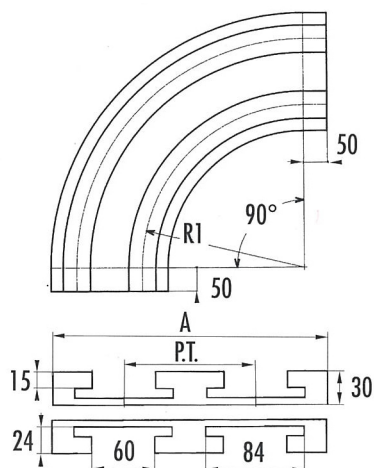

Para corrente TK 4 1/2"

90° - R1 = 610 mm.

Sec. A x 30 + 30 - Parte recta 50 mm.

Código	Pistas	P.T. mm	A mm
TR 4 1/2" - 610-1	1	-	130
TR 4 1/2" - 610-2	2	120	250

Para corrente TK6

90° - R1 = 610 mm.

Sec. A x 30 + 30 - Parte recta 50 mm.

Código	Pistas	P.T. mm	A mm
TR 6 - 610-1	1	-	185

Para corrente TK 7 1/2"

90° - R1 = 610 mm.

Sec. A x 30 + 30 - Parte recta 50 mm.

Código	Pistas	P.T. mm	A mm
TR 7 1/2" - 610-1	1	-	200
TR 7 1/2" - 610-2	2	196	396

Para corrente TK 10

90° - R1 = 610 mm.

Sec. A x 30 + 30 - Parte recta 50 mm.

Código	Pistas	P.T. mm	A mm
TR 10-610-1	1	-	270
TR 10-610-2	2	260	530

Para corrente TK 12

90° - R1 = 610 mm.

Sec. A x 30 + 30 - Parte recta 50 mm.

Código	Pistas	P.T. mm	A mm
TR 12-610-1	1	-	320
TR 12-610-2	2	310	630

Para corriente TK 3 1/4"
90° - R1 = 500 mm.

Sec. A x 35 + 35 - Parte recta 50 mm.

Código	Pistas	P.T. mm	A mm
TC 3 1/4"-500-1	1	-	100
TC 3 1/4"-500-2	2	88	190
TC 3 1/4"-500-3	3	88	280
TC 3 1/4"-500-4	4	88	370

Para corriente TK 6

90° - R1 = 500 mm.

Sec. A x 35 + 35 - Parte recta 50 mm.

Código	Pistas	P.T. mm	A mm
TC 6-500-1	1	-	170
TC 6-500-2	2	160	330

Para corrientes TAB (1873T / 1874T)

Para corriente TK 4 1/2"

90° - R1 = 500 mm.

Sec. A x 35 + 35 - Parte recta 50 mm.

Código	Pistas	P.T. mm	A mm
TC 4 1/2"-500-1	1	-	130
TC 4 1/2"-500-2	2	120	250

Para corriente TK 7 1/2"

90° - R1 = 500 mm.

Sec. A x 35 + 35 - Parte recta 50 mm.

Código	Pistas	P.T. mm	A mm
TC 7 1/2"-500-1	1	-	200
TC 7 1/2"-500-2	2	196	390

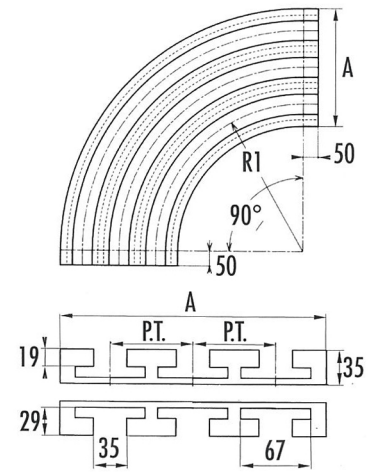

POR CONSULTA TK10 / TK12 / TK16

Rectas com 2 mt.

Para corrientes TAB (880T / 881T)

D-T

Sec. A x 25

Código	A mm
D - T 3 1/4"-1	100
D - T 4 1/2"-1	130
D - T 7 1/2"-1	200

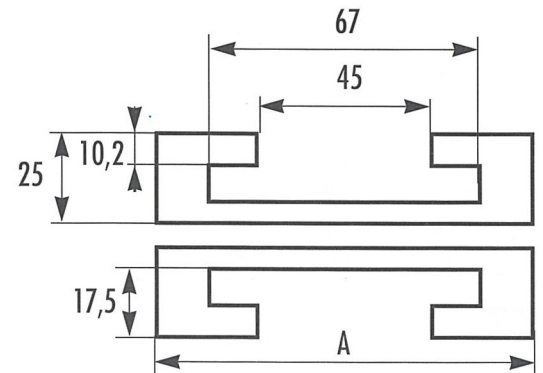

Para corrientes TAB (882T)

D-TR

Sec. A x 30

Código	A mm
D - TR 4 1/2"-1	130
D - TR 6-1	185
D - TR 7 1/2"-1	200
D - TR 10-1	270
D - TR 12-1	320

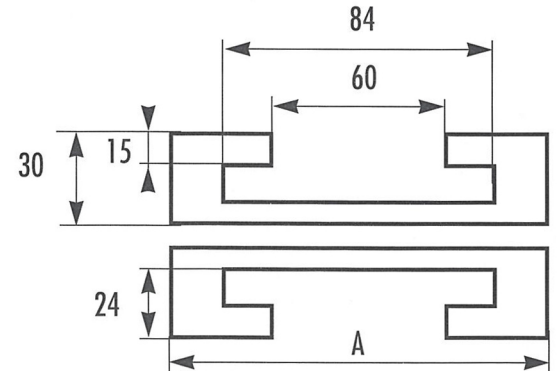

Para corrientes TAB (1873T - 1874T)

D-TC

Sec. A x 35

Código	A mm
D - TC 4 1/2"-1	100
D - TC 6-1	130
D - TC 7 1/2"-1	170
D - TC 10-1	200
D - TC 12-1	270
D - TC 16-1	320

